

# PHASE CONTROL THYRISTOR H150TBXX

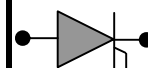

Symbol	Characteristics	Conditions	$T_J$ ( $^{\circ}\text{C}$ )	Value	Unit
<b>BLOCKING PARAMETERS</b>					
$V_{RRM}$	Repetitive peak reverse voltage		125	200-1600	V
$V_{DRM}$	Repetitive peak off-stage voltage		125	200-1600	V
$I_{RRM}$	Repetitive peak reverse current	$V = V_{RRM}$	125	25	mA
$I_{DRM}$	Repetitive peak off-state current	$V = V_{RRM}$	125	25	mA
<b>CONDUCTING PARAMETERS</b>					
$I_{F(AV)}$	Average on-state current	180 sine, 50Hz, $T_C = 70^{\circ}\text{C}$		150	A
$I_{RMS}$	RMS on-state current			235	A
$I_{TSM}$	Surge on-state current	Sine wave, 10mS without reverse voltage	125	3	kA
$I^2t$	$I^2t$			45	$\text{kA}^2\text{S}$
$V_T$	Peak on-state voltage drop	On-state current = 470A	125	1.80	V
$V_0$	Threshold voltage		125	0.90	V
$R_0$	On-state slope resistance		125	1.80	$\text{m}\Omega$
<b>TRIGGERING PARAMETERS</b>					
$I_{GT}$	Gate trigger current	$V_D = 5V$	25	150	mA
$V_{GT}$	Gate trigger voltage		25	2.00	V
$I_L$	Latching Current	$V_D = 5V$	25	600	mA
$P_{G-PEAK}$	Maximum Peak Gate Power	Pulse width 100 $\mu\text{Sec}$		120	W
di/dt	Repetitive rate of rise of current			150	$\text{A}/\mu\text{Sec}$
$V_{FGM}$	Maximum forward gate voltage			12	V
$I_{FGM}$	Maximum forward gate current			25	A
<b>THERMAL &amp; MECHANICAL PARAMETERS</b>					
$R_{TH(J-C)}$	Thermal impedance, 180 conduction, Sine	Junction to case		0.234	$^{\circ}\text{C}/\text{W}$
$R_{TH(C-HK)}$	Thermal impedance	Case to heatsink		0.08	$^{\circ}\text{C}/\text{W}$
$T_J$	Maximum Permissible junction temperature			125	$^{\circ}\text{C}$
$T_{STG}$	Storage temperature range			-40 - 125	$^{\circ}\text{C}$
F	Mounting Torque			14	NM
W	Weight			200	gms



# PHASE CONTROL THYRISTOR H150TBXX

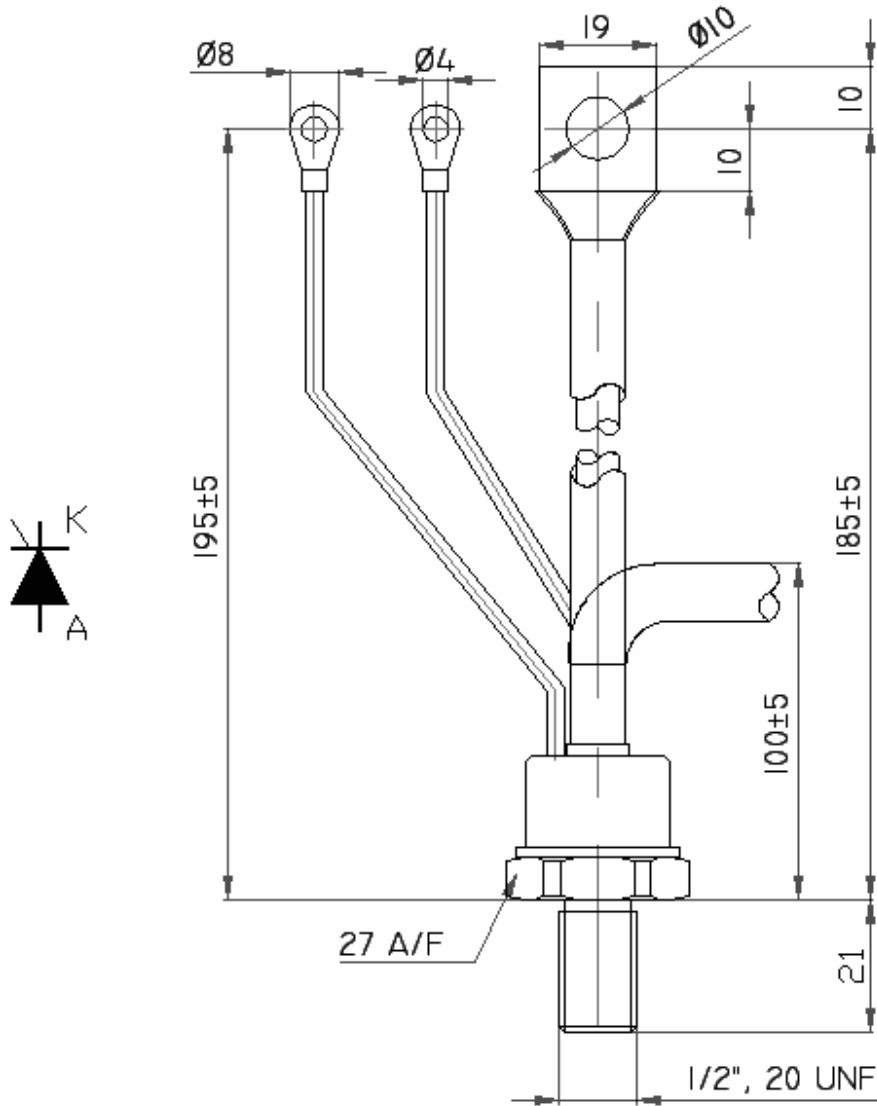
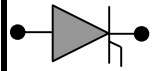

All dimensions in mm

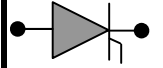

On State Power Loss

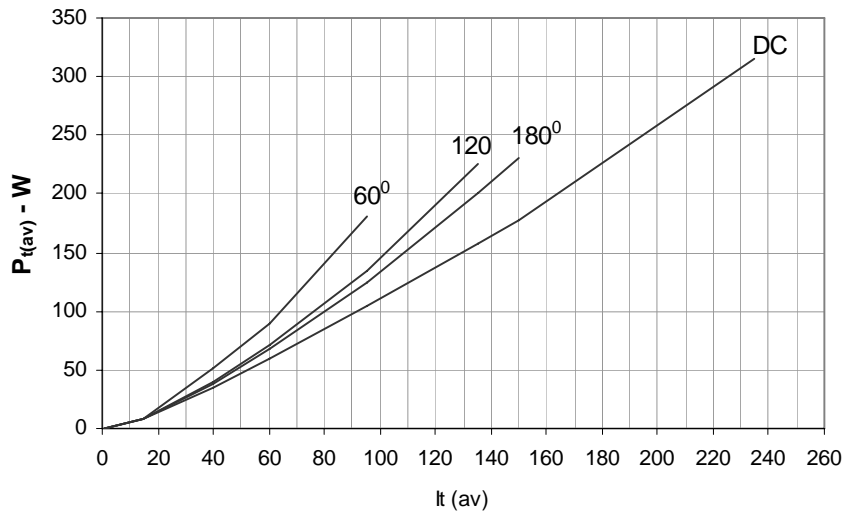

Maximum Permissible Case Temp

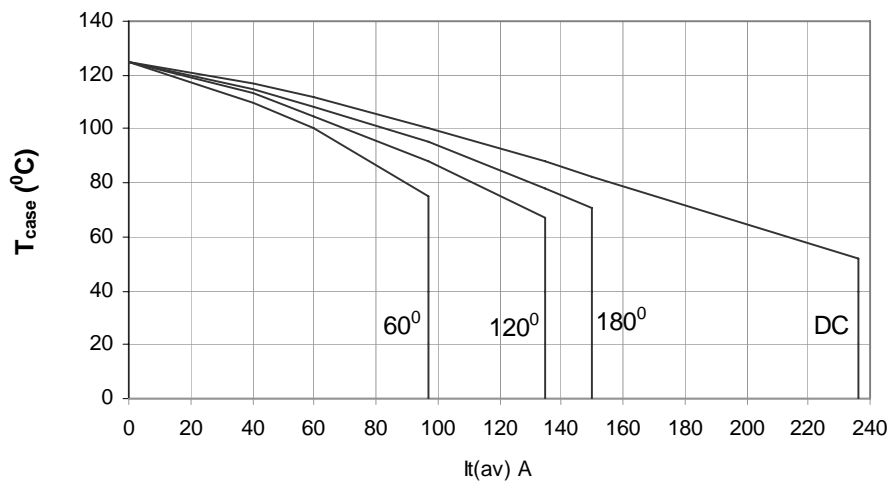

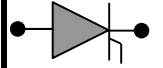

## Max non repetitive Surge Current

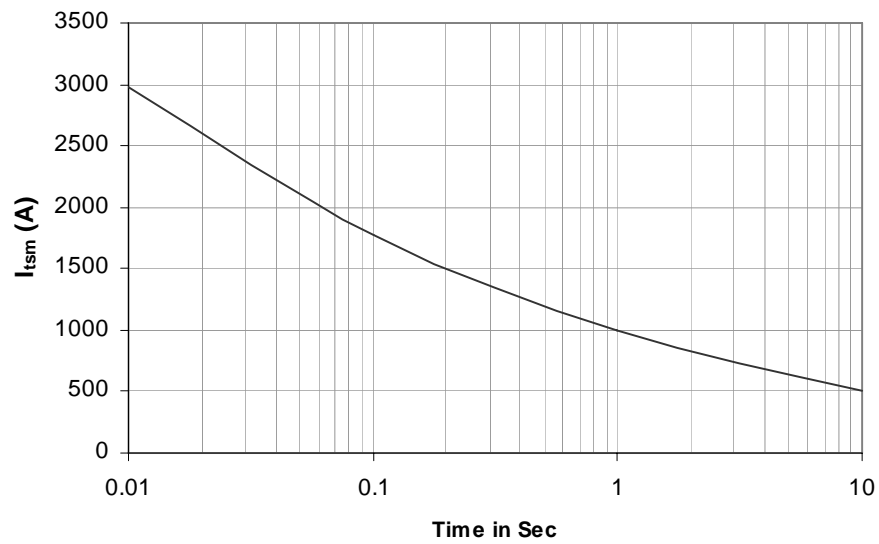

## Transient Thermal Impedance Junction to Case

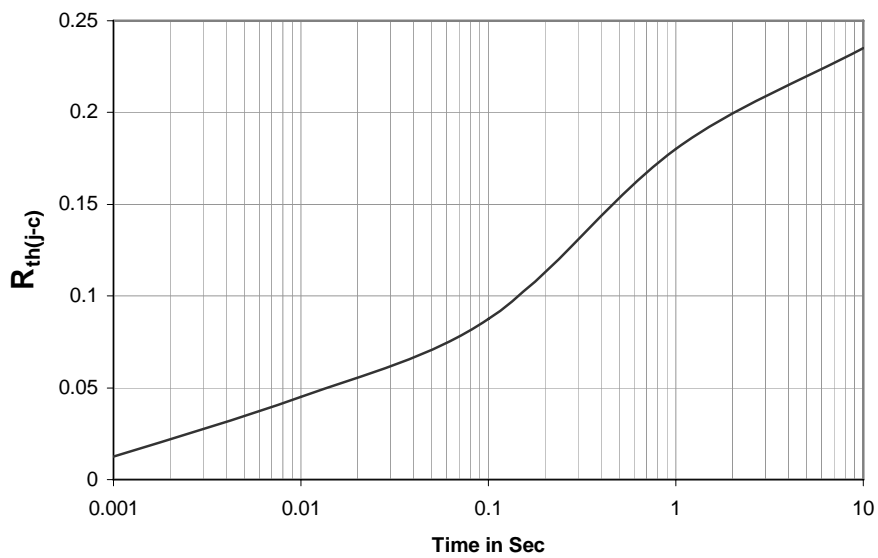

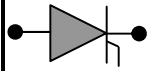

On State Characteristics

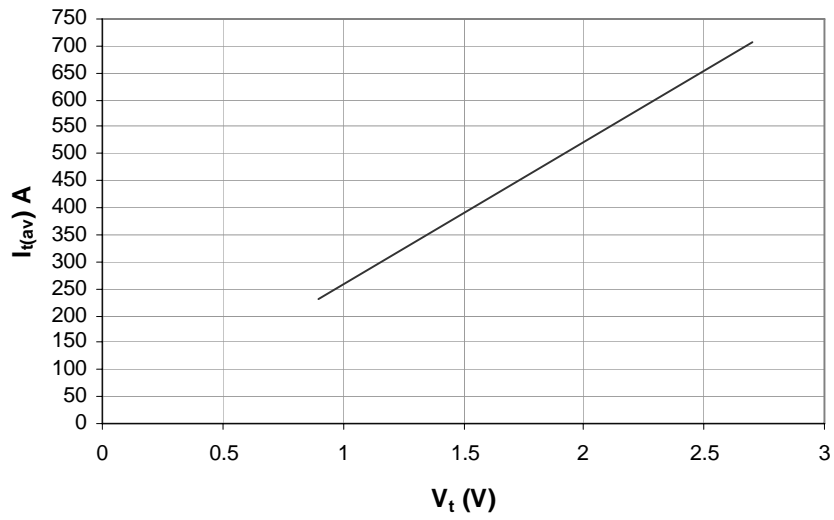

Gate Trigger Characteristics

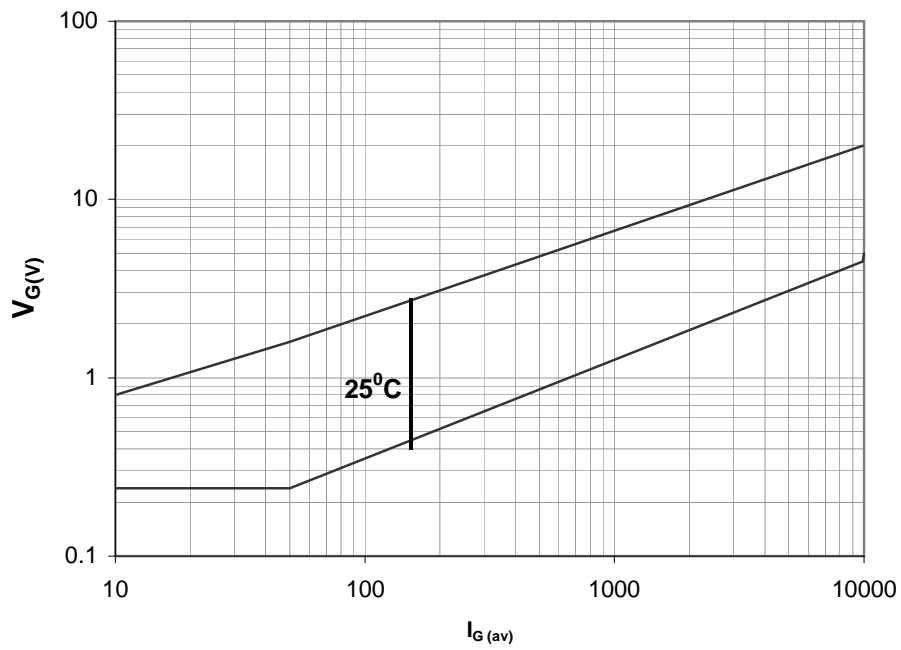

## PHASE CONTROL THYRISTOR H150TBXX

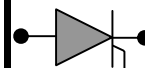

### Ordering Information: -

<b>H</b>	<b>150</b>	<b>TB</b>	<b>XX</b>
Hirect make Thyristor	$I_{F(AV)} = 150A$	TB – with a Pigtail	$V_{RRM} = XX * 100$ e.g. 12 * 100 = 1200V

Hind Rectifiers Ltd reserves the right to change the specifications without notice.

This datasheet specifies technical information for semiconductor devices but promises no characteristics. No warranty or guarantee expressed or implied is made regarding delivery, performance or suitability.

Hind Rectifiers Ltd  
Lake Road  
Bhandup (West)  
Mumbai – 400 078  
Tel: - +91 22 2596 8027/28/29/31  
Fax: - +91 22 2596 4114  
E-mail: - [marketing@hirect.com](mailto:marketing@hirect.com)  
Website: - [www.hirect.com](http://www.hirect.com)

June-2008



**HIND RECTIFIERS LTD**

6 of 6