

Rectifier Diode SXXHNS/HRS201

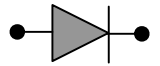

Symbol	Characteristics	Conditions	$T_J(^{\circ}\text{C})$	Value	Unit
BLOCKING PARAMETERS					
V_{RRM}	Repetitive peak reverse voltage		180	200-1500	V
I_{RRM}	Repetitive peak reverse current	$V = V_{RRM}$	180	30	mA
CONDUCTING PARAMETERS					
$I_{F(AV)}$	Average on-state current	180 sine, 50Hz, $T_C = 130^{\circ}\text{C}$		200	A
I_{RMS}	RMS on-state current			300	A
I_{FSM}	Non repetitive peak surge on-state current	Sine wave, 10mS without reverse voltage	180	3600	A
I^2t	Permissible surge energy			64.8	kJ ² S
V_{FM}	Peak on-state voltage drop	On-state current = 470A	180	1.25	V
V_0	Typical forward conduction Threshold voltage		180	0.75	V
r_0	Typical forward slope resistance		180	0.90	m Ω
THERMAL & MECHANICAL PARAMETERS					
$R_{TH(J-C)}$	Thermal impedance, 180 ^o conduction, Sine	Junction to case		0.24	^o C/W
$R_{TH(C-HK)}$	Thermal impedance	Case to heatsink		0.05	^o C/W
T_J	Maximum Permissible junction temperature			180	^o C
T_{STG}	Storage temperature range			-40 – 180	^o C
F	Mounting Torque			13.5	NM
W	Weight			180	gms



HIND RECTIFIERS LTD

Rectifier Diode SXXHNS/HRS201

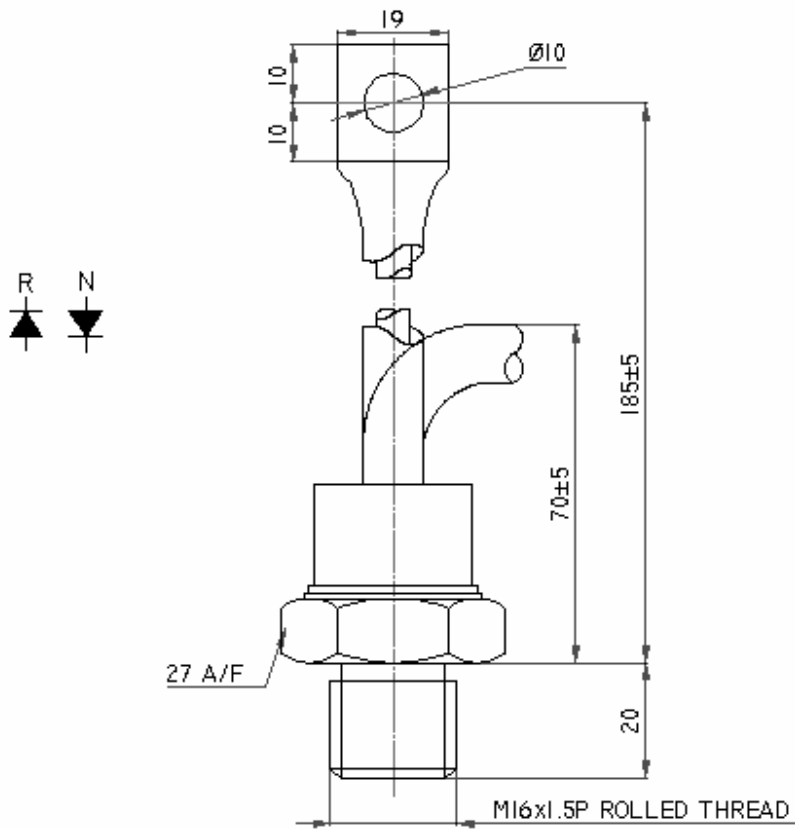
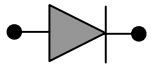

All dimensions in mm

On State Power Loss

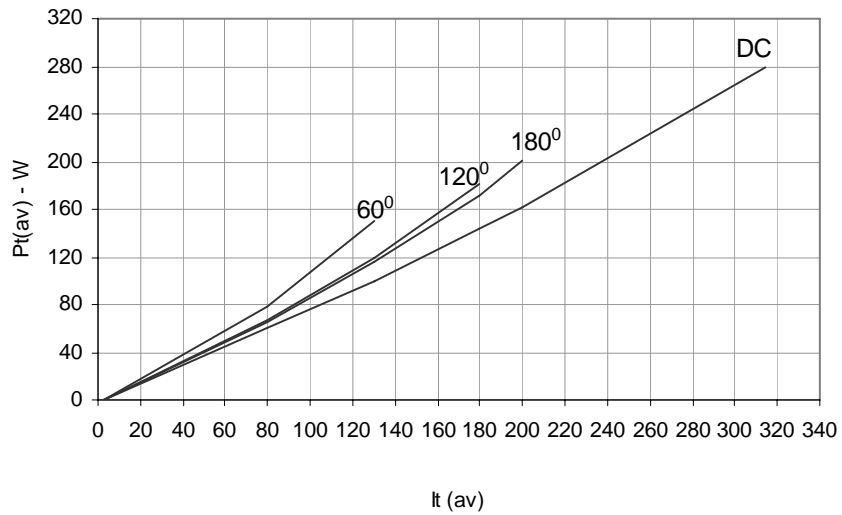

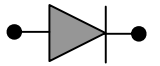

Maximum Permissible Case Temp

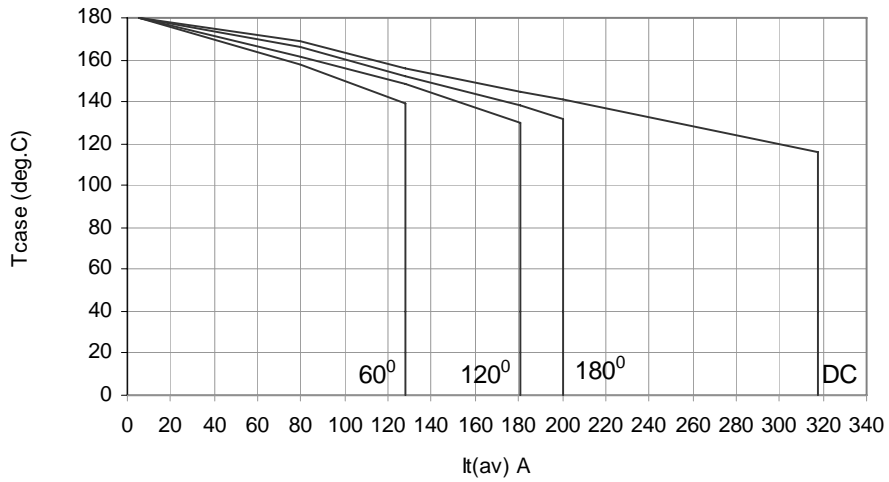

Max non repetitive Surge Current

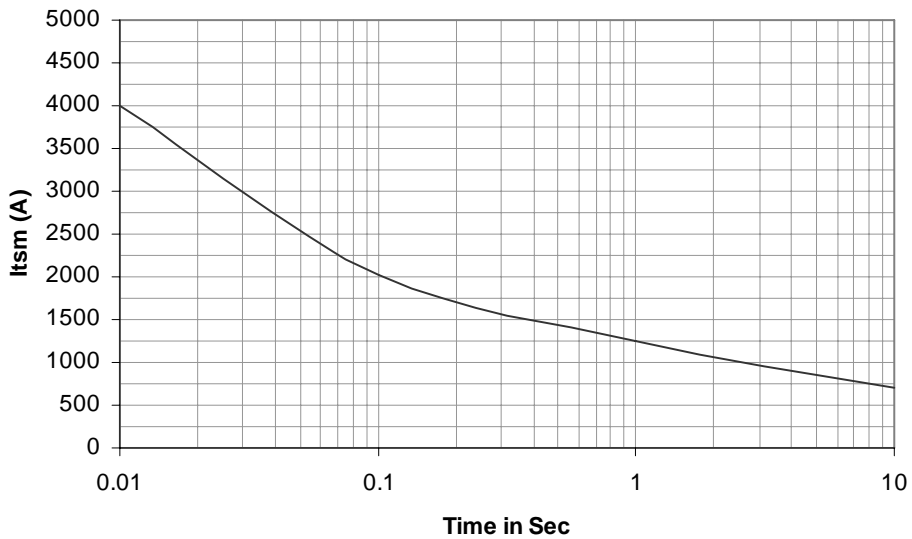

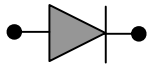

Transient Thermal Impedance Junction to Case

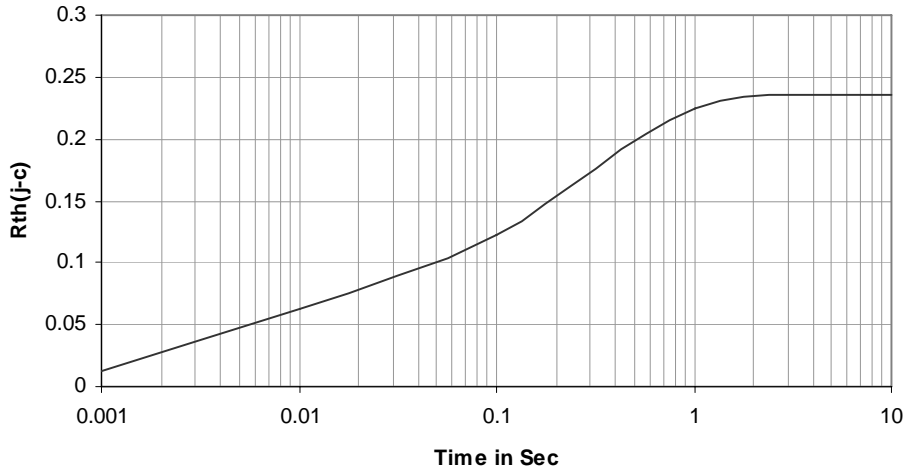

On State Characteristics

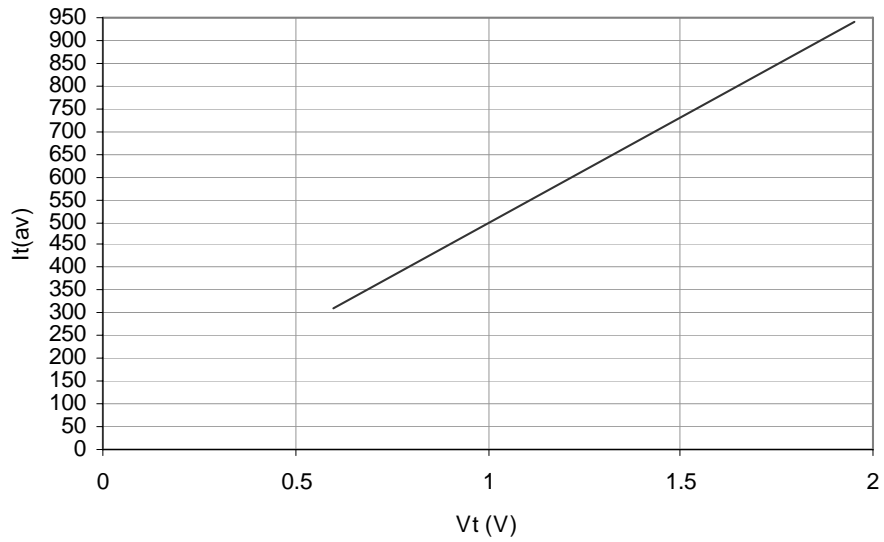

Rectifier Diode SXXHNS/HRS201

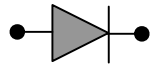

Ordering Information: -

S	XX	HNS / HRS	201
Hirect make Rectifier Diode	$V_{RRM} = XX * 100$ e.g. 12 * 100 = 1200V	HNS - Normal Polarity HRS - Reverse Polarity	$I_{F(AV)} = 200A$

Hind Rectifiers Ltd reserves the right to change the specifications without notice.

This datasheet specifies technical information for semiconductor devices but promises no characteristics. No warranty or guarantee expressed or implied is made regarding delivery, performance or suitability.

Hind Rectifiers Ltd
Lake Road
Bhandup (West)
Mumbai – 400 078
Tel: - +91 22 2596 8027/28/29/31
Fax: - +91 22 2596 4114
E-mail: - marketing@hirect.com
Website: - www.hirect.com

June-2008



HIND RECTIFIERS LTD

5 of 5