

Capsule Type Rectifier Diode SHXXC2230

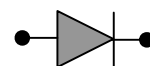

Symbol	Characteristics	Conditions	$T_J(^{\circ}\text{C})$	Value	Unit
BLOCKING PARAMETERS					
V_{RRM}	Repetitive peak reverse voltage		180	200-1800	V
I_{RRM}	Repetitive peak reverse current	$V = V_{RRM}$	180	50	mA
CONDUCTING PARAMETERS					
$I_{F(AV)}$	Average on-state current	180 sine, 50Hz, $T_C = 109^{\circ}\text{C}$		2230	A
I_{RMS}	RMS on-state current			3500	A
I_{FSM}	Non repetitive peak surge on-state current	Sine wave, 10mS without reverse voltage	180	25000	A
I^2t	Permissible surge energy			3125	KA ² S
V_{FM}	Peak on-state voltage drop	On-state current = 3000A	180	1.10	V
V_0	Typical forward conduction Threshold voltage		180	0.70	V
r_0	Typical forward slope resistance		180	0.10	m Ω
THERMAL & MECHANICAL PARAMETERS					
$R_{TH(J-C)}$	Thermal impedance, 180 ^o conduction, Sine	Junction to case		0.0255	^o C/W
$R_{TH(C-HK)}$	Thermal impedance	Case to heatsink		0.005	^o C/W
T_J	Maximum Permissible junction temperature			180	^o C
T_{STG}	Storage temperature range			-40 – 180	^o C
F	Mounting Torque			15	KN
W	Weight			340	gms



HIND RECTIFIERS LTD

Capsule Type Rectifier Diode SHXXC2230

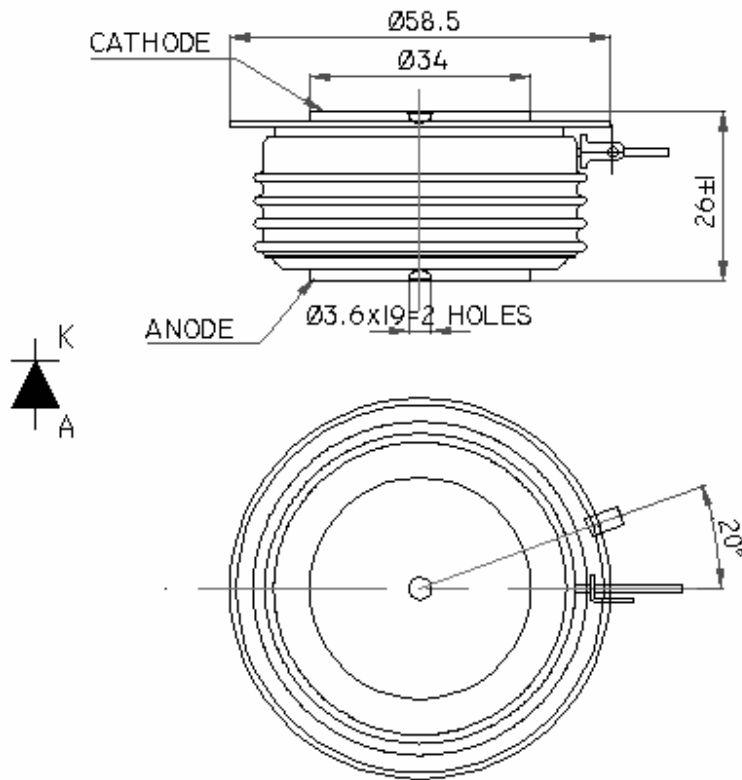
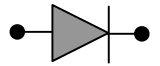

All dimensions in mm

On State Power Loss

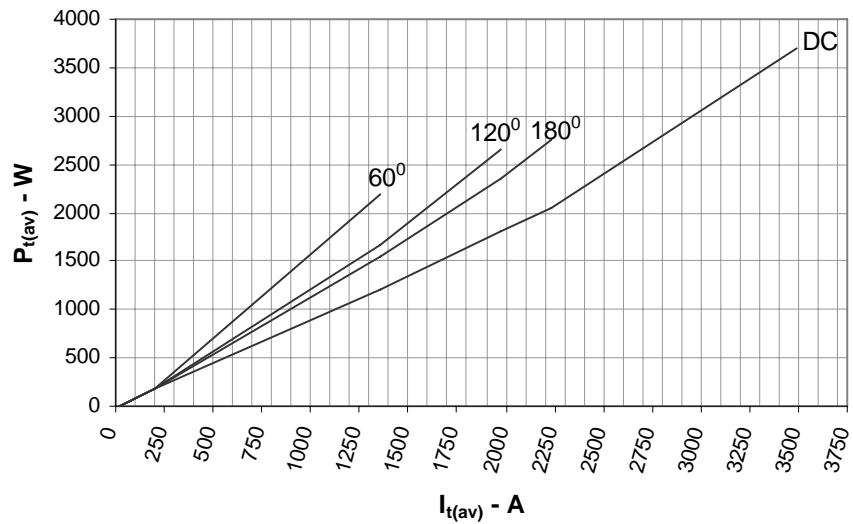

HIND RECTIFIERS LTD

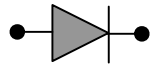

Maximum Permissible Case Temp

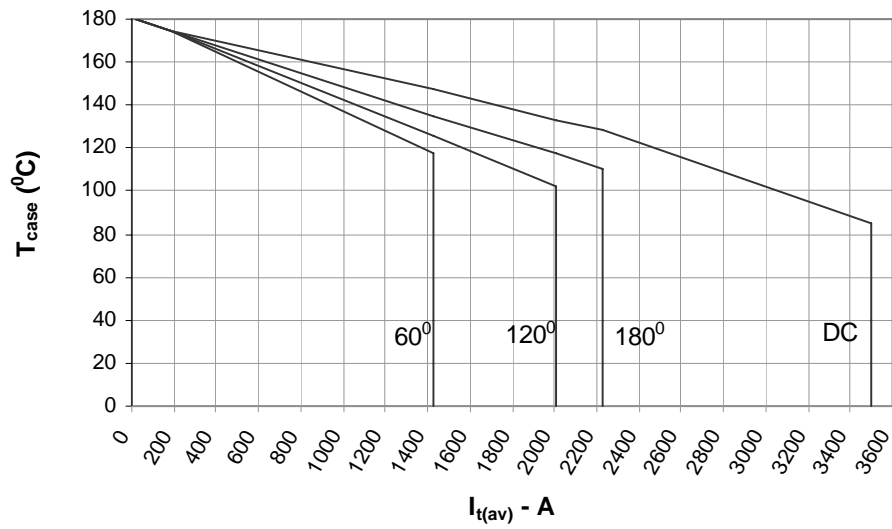

Max non repetitive Surge Current

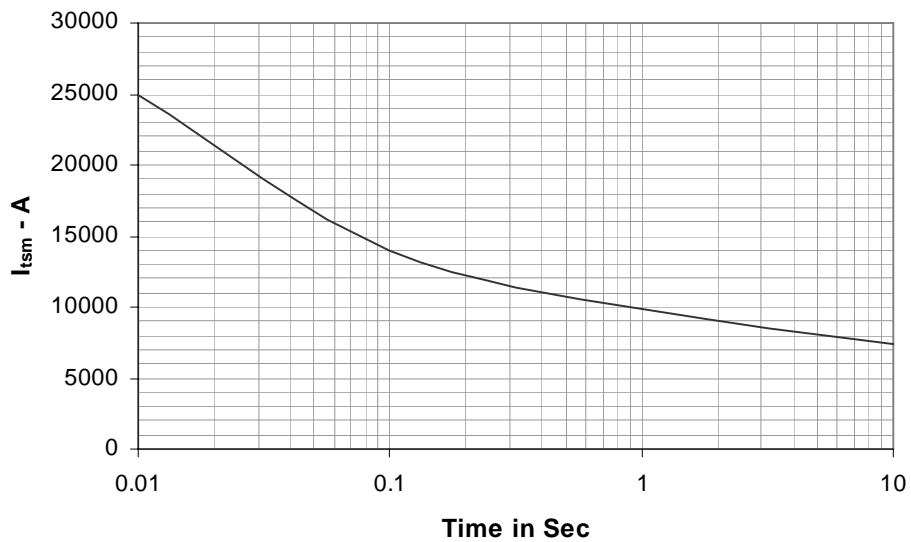

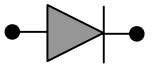

Transient Thermal Impedance Junction to Case

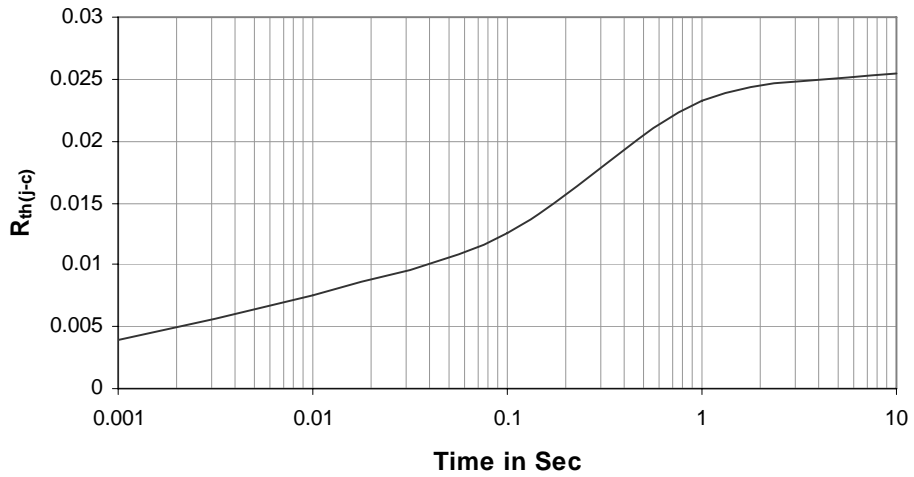

On State Characteristics

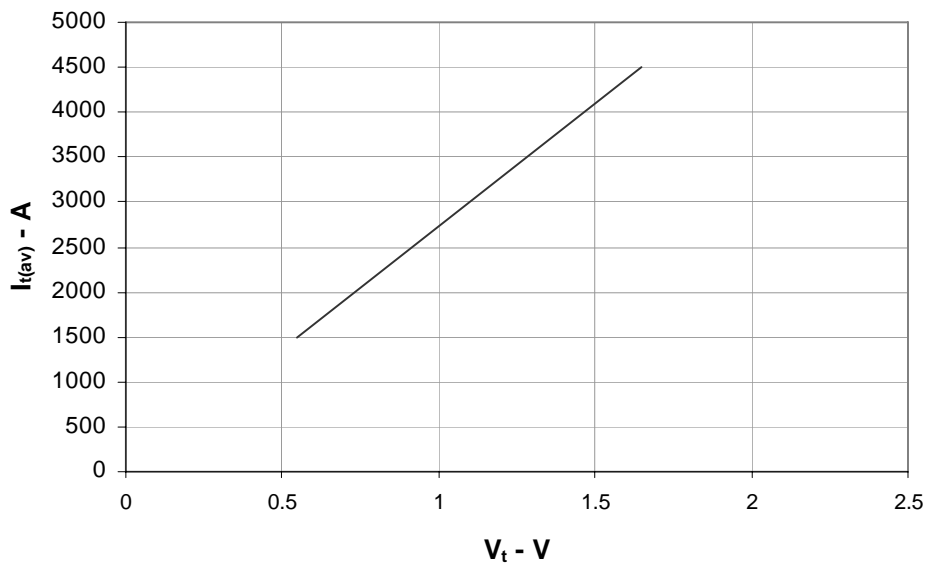

Capsule Type Rectifier Diode SHXXC2230

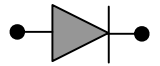

Ordering Information: -

SH	XX	C	2230
Hirect make Capsule Diode	$V_{RRM} = XX * 100$ e.g.12 * 100 =1200V	Capsule Diode	$I_{F(AV)} = 2230A$

Hind Rectifiers Ltd reserves the right to change the specifications without notice.

This datasheet specifies technical information for semiconductor devices but promises no characteristics. No warranty or guarantee expressed or implied is made regarding delivery, performance or suitability.

Hind Rectifiers Ltd
Lake Road
Bhandup (West)
Mumbai – 400 078
Tel: - +91 22 2596 8027/28/29/31
Fax: - +91 22 2596 4114
E-mail: - marketing@hirect.com
Website: - www.hirect.com

June-2008



HIND RECTIFIERS LTD

5 of 5